

# SPARK

**Proiettore per interni ed esterni costituito da:**

- Corpo in alluminio pressofuso verniciato
- Diffusore in vetro trasparente temperato
- Parabola riflettente in alluminio
- Guarnizioni in silicone
- Viti di chiusura in acciaio inox
- Picchetto in plastica
- Verniciatura in polveri poliestere ad elevata resistenza ai raggi ultravioletti e alla corrosione

**Indoor and outdoor spotlight constructed of:**

- Painted die-cast aluminium body
- Transparent tempered glass diffuser
- Aluminium reflector
- Silicon gaskets
- Stainless steel screws
- Plastic spike
- Painting using high resistance to UV and corrosion polyester powders



# SPARK STELO

**Apparecchio per esterni costituito da:**

- Corpo in alluminio pressofuso verniciato
- Palo in alluminio estruso verniciato
- Diffusore in vetro

**Outdoor post luminaire constructed of:**

- Painted die-cast aluminium body
- Painted extruded aluminium post
- Glass diffuser

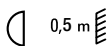

**Colori - Colours**

**X=9**  Antracite  
Anthracite

**X=4**  Silver

**Diffusore - Diffuser**

**Codice-Code 00 1080**

**Le lampadine vengono fornite solo su richiesta**

Bulbs supplied only on request

**Classe energetica : vedi pag. 356**

Energy class : see page 356

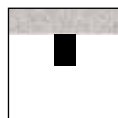

**Cod. 1080 - 1081**  
**Installazione a soffitto**  
Ceiling mounting

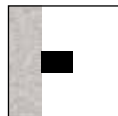

**Cod. 1080 - 1081**  
**Installazione a parete**  
Wall mounting

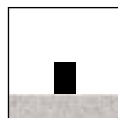

**Cod. 1082 - 1083 - 1086 - 1088**  
**Installazione a terra**  
Floor mounting

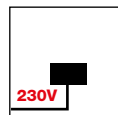

**LED**  
**Led a tensione di rete 220/240V 50/60Hz.**  
**Connessione diretta alla rete di alimentazione senza necessità di trasformatore.**  
LED's direct operation at 220/240V 50/60Hz.  
No transformer is required.



**IK 07**

**SPARK CON PICCHETTO A TERRA**  
**Apparecchio provvisto di cavo H05RN-F con spina 2P+T IP44**

**SPARK WITH GROUND SPIKE**  
Luminaire provided with flexible cable H05RN-F and plug 2P+T IP44





**1080** ○ anello / ring  
**1081** ● griglia / grid

**Installazione a parete**

Wall mounting

● <b>1080.06X</b>	🔊	E27	PAR30	LED 10W	940 lm	3000 K	25°
<b>1080.45X</b>				LED	17,6W	2270 lm	4000 K
<b>1080.46X</b>				LED	17,6W	2125 lm	3000 K
● <b>1081.06X</b>	🔊	E27	PAR30	LED 10W	940 lm	3000 K	25°
<b>1081.45X</b>				LED	17,6W	2270 lm	4000 K
<b>1081.46X</b>				LED	17,6W	2125 lm	3000 K

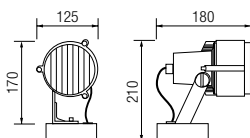

**1082** ○ anello / ring  
**1083** ● griglia / grid

**Installazione a terra con picchetto**

Ground fixing with spike

● <b>1082.06X</b>	🔊	E27	PAR30	LED 10W	940 lm	3000 K	25°
<b>1082.45X</b>				LED	17,6W	2270 lm	4000 K
<b>1082.46X</b>				LED	17,6W	2125 lm	3000 K
● <b>1083.06X</b>	🔊	E27	PAR30	LED 10W	940 lm	3000 K	25°
<b>1083.45X</b>				LED	17,6W	2270 lm	4000 K
<b>1083.46X</b>				LED	17,6W	2125 lm	3000 K

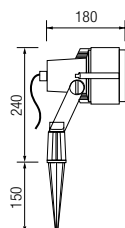

**1088** H 700 ○ anello / ring  
**1086** H 450 ○ anello / ring

● <b>1088.06X</b>	🔊	E27	PAR30	LED 10W	940 lm	3000 K	25°
<b>1088.45X</b>				LED	17,6W	2270 lm	4000 K
<b>1088.46X</b>				LED	17,6W	2125 lm	3000 K
● <b>1086.06X</b>	🔊	E27	PAR30	LED 10W	940 lm	3000 K	25°
<b>1086.45X</b>				LED	17,6W	2270 lm	4000 K
<b>1086.46X</b>				LED	17,6W	2125 lm	3000 K

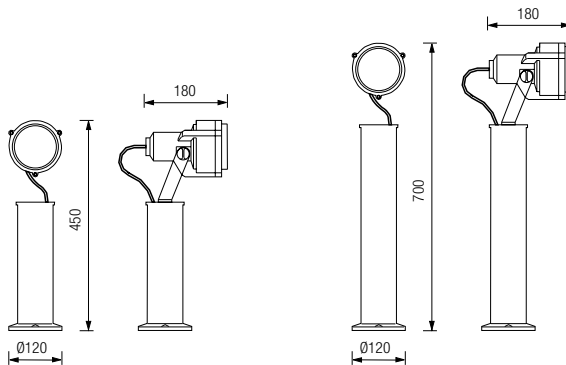

**1086** H 450

**1088** H 700

- L'apparecchio viene fornito completo di lampadina LED PAR 30  
 Bulb enclosed to the luminaire LED PAR 30