



Projector with street optics characterised by a graceful and refined design that, thanks to a series of performing optics, ensures it can be used for street furniture for the lighting of outside business areas, public squares, urban routes, parking places and facades.

#### **Construction characteristics**

Body and glass-holding cover in die cast aluminium varnished with polyester powders in silver colour, after phosphodegreasing, phosphocromatising and the application of a protection coating aimed at ensuring excellent resistance to corrosion.

All electrical components are certified with ENEC mark (230V, 50 Hz). The projector has been manufactured according to EN 60598/1 standards.

# MACH 5 WAY



Cover hinged in the body bottom and held with stainless steel small items. Lamp-holder in porcelain 16A with anti-unscrewing device. Installation by means of a strong steel fork, galvanised and varnished with polyester powders in metallised grey colour. Double goniometric scale for vertical mounting. Gaskets in anti-aging silicon rubber. Tempered glass suitable for high temperature, thermal shocks and crashes (6 Joule), mechanically fixed to the glass-holding ring. The power supply cable accesses the device through a PG 13.5 cable gland (anti-tear IP 68) Pressure compensation filter in teflon. Opening and access to optics and control gear with a single operation, by using the high mechanical resist-

ance stainless steel front spring. Extractable electrical tool holding plate in galvanised steel for Class I. Insulating Class II with disconnecting switch for supply line break when the cover is open. Wiring board with electrical unit with improved power factor ( $\cos \varphi > 0.90$ ) in special self-extinguishing thermoplastic material V0. The board can be easily removed to make maintenance operations easier. It can be cutaway from the supply line through non-reversible connectors with quick coupling. The device can be directly installed on a 60 mm diameter pole, with die casting accessory suitable for single and double mounting and wall mounting for single projector.



## CL I

CODE	DESCRIPTION	LAMP TYPE	WEIGHT (kg)	PACKING (pcs.)	PALLET (pcs.)	CBMS
35001*	CR	S (SAP) 70W	11,40	1	40	0,0494
35002	CR	M-S (JM-SAP) 100W	11,50	1	40	0,0494
35003	CR	M-S (JM-SAP) 150W	12,05	1	40	0,0494
35004**	CR	M-S (JM-SAP) 250W	13,35	1	40	0,0494
35005**	CR	M-S (JM-SAP) 400W	14,45	1	40	0,0494
35006	CR	M (JM) 70W	11,40	1	40	0,0494
35007	CR	M (JM) 250W Philips type	12,20	1	40	0,0494
35008	CR	M (JM) 400W Philips type	13,25	1	40	0,0494
35010	CR	QE (MBF) 125W	11,30	1	40	0,0494
35011	CR	QE (MBF) 250W	12,10	1	40	0,0494

\* With ignitor.

\*\* Suitable for MH lamps Osram type, see lamps technical specifications.

## CL II

CODE	DESCRIPTION	LAMP TYPE	WEIGHT (kg)	PACKING (pcs.)	PALLET (pcs.)	CBMS
35051*	CR	S (SAP) 70W	11,40	1	40	0,0494
35052	CR	M-S (JM-SAP) 100W	11,50	1	40	0,0494
35053	CR	M-S (JM-SAP) 150W	12,05	1	40	0,0494
35054**	CR	M-S (JM-SAP) 250W	13,35	1	40	0,0494
35056	CR	M (JM) 70W	11,40	1	40	0,0494
35057	CR	M (JM) 250W Philips type	12,20	1	40	0,0494
35060	CR	QE (MBF) 125W	11,30	1	40	0,0494
35061	CR	QE (MBF) 250W	12,10	1	40	0,0494

\* With ignitor

\*\* Suitable for MH lamps Osram type, see lamps technical specifications.

Lamps	
	QE (MBF) - E27 125W - E40 250W
	SE (SAP-E) - E27 70W - E40 100-150-250W
	ST (SAP-T) - E27 70W - E40 100-150-250-400W
	MT (JM-T) - E27 70W - E40 100-150-250-400W
	ME (JM-E) - E27 70W - E40 100-150-250W

## Dimensions (mm)

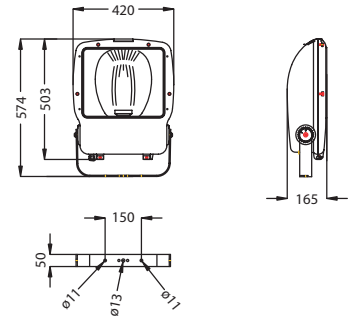

## Working position

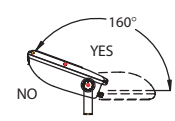

Wind-exposed surface:  
m<sup>2</sup> 0,09 with vertical  
addressing 0°.

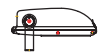

# MACH 5 WAY

## ACCESSORIES AND SPARE PARTS

CODE	DESCRIPTION	GROSS WEIGHT (kg)	PACKING (pcs.)	COLOUR	CBMS
60239	Extension arm length mm 850	6,50	1	Silver	0,0415
60235	AKRON 1	0,500	1	Silver	0,0010
60237	AKRON 2	0,500	1	Silver	0,0010
60238	AKRON 3	1,65	1	Silver	0,0082



**60239**  
Extension arm length mm 850.  
Zinc plated and steel coated in glazed

The **Akron** installation modular system has been properly studied for the Mach 5 way floodlights and it is available in the following versions:



**AKRON 1** **codice 60235**  
Single top pole mounting support in die cast alluminium block ø mm 60 painted in glazed silver colour.

**AKRON 2** **codice 60237**  
Double top pole mounting support in die cast alluminium twin block ø mm 60 painted in glazed silver colour.

**AKRON 3** **codice 60238**  
Wall mounting single support for horizontal aiming in die cast alluminium block painted in glazed silver colour.

### Photometric data

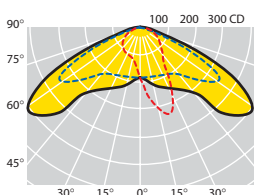

ST (SAP-T) 250W E 40  
POS. A C max=15°

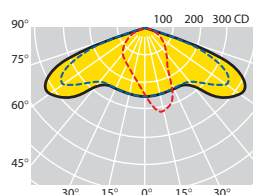
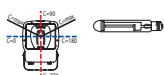

ST (SAP-T) 400W E 40  
POS. A C max=5°

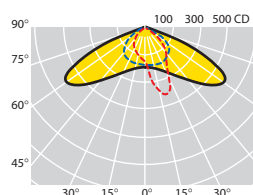
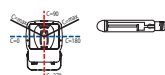

ST (SAP-T) 150W E 40  
POS. A C max=30°

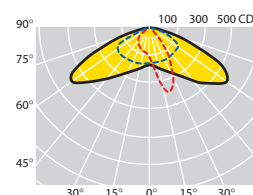
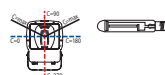

ST (SAP-T) 150W E 40  
POS. B C max=25°

