

LIGHTMASTER ONE

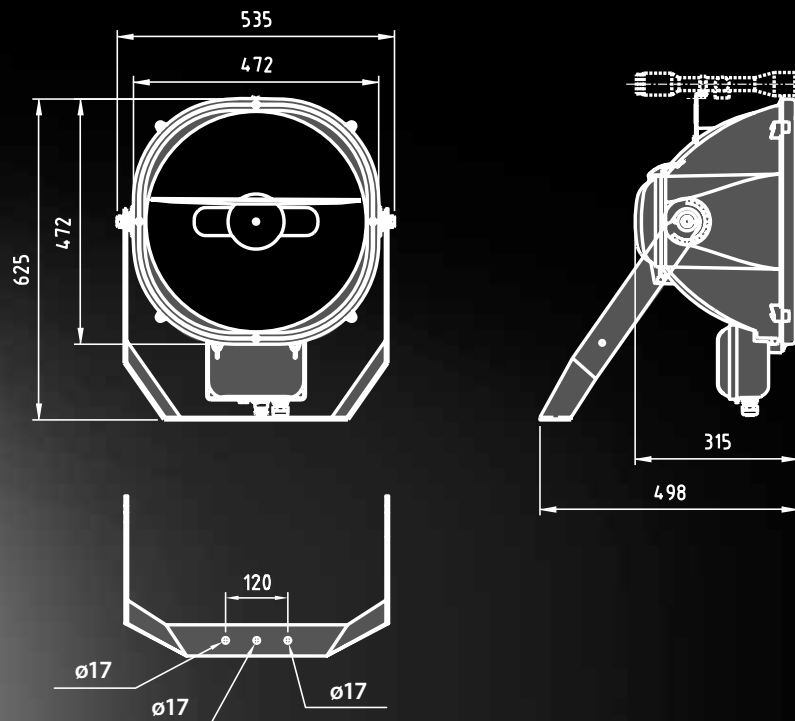



When the light becomes design

The bodies, lightweight and compact, are manufactured in die cast aluminium, with primary alloy and low copper content with a high tight rating.

The enhanced construction design reduces the weight and allows easy handling during mounting and aiming phases. The design, with the characteristic cooling fins, reduces wind resistance to a minimum.

The **LIGHTMASTER ONE** floodlights have

been designed to light up:

- medium and large stadiums with HD cameras
- sports halls
- large indoor sports areas
- events and shows in large open areas.

The projectors are suitable for installation on masts and line arrangements at heights up to 50/70 meters above and around the surface area.

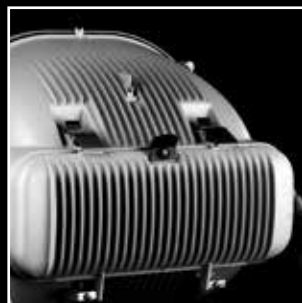

Technical features of Lightmaster One

Aiming

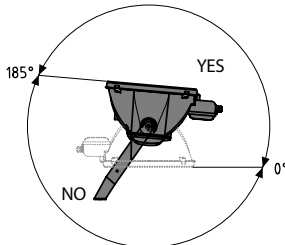

1000W

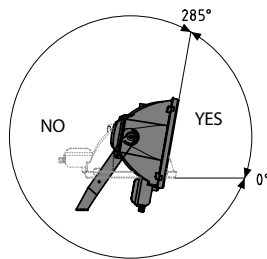

2000W

The aiming is achieved both with a mechanical sighting device, using a lateral protractor scale that indicates the angle of tilt and can be used for pre-aiming, or, for a more precise aiming, a telescope 6x36 mounted on the sighting device (optional).

Description

CHARACTERISTICS

- Body, rear cover and glass frame in die cast aluminium with primary alloy and low copper content, with a high weather proof rating.
- Coated with silver polyester powder.
- Front tempered glass resistant to high temperatures and to thermal shock.
- Anti-ageing gaskets in silicon rubber.
- Hot deep galvanized sheet steel fixing bracket.
- Connection box in special selfextinguish plastic material, complete with ignitor.
- Two pressure compensation filters in teflon.
- Insulation class I and II.
- Protection degree against external impacts: IK 08.
- Floodlight body weight Kg 13,50.
- Wind exposed surface with tilt $70^\circ = 0,20 \text{ m}^2$.
- Control gear box CABLO SERVICE, in die-cast aluminium IP 65 for class I or in thermoplastic material IP 66 for class II, may be used for the supply of the lamp.
- The projector can be equipped with the innovative and efficient metal halide lamp 2000W high flow (230000 lm), requiring the versions especially designed for this lamp. Even the power supplies unit must be requested in special version.
- The mounting distances between the gear box and the body can be up to 50/70 meters, as the ignitor is fitted within the rear housing of the projector.
- Designed for indoor and outdoor applications.
- The fixture is approved for nominal temperature of 35°C . Thus, according to EN 60598-1, the fixture can be used, for discontinuous periods, at 45°C .
- Hot Restrike version for short arc lamp available on request (for 1000W Hot Restrike please specify if it's used for up or down lightings). In these versions, to allow the maintenance of the distances for high voltage, the lighting performances are 5% lower compared to the standard version.

OPTICAL SYSTEM

High Intensity **paraboloid rotational reflector**, made by optics R1, R2, R3, R4, R5, R6, R7, R8, R9 for short arc lamps. The careful study of the optics and the choice of high-performing materials allows an excellent control of the luminous flux and a considerable glare reduction thanks to the centering device of the lamp. The deflector allows a huge glare reduction, providing an excellent visual comfort.

LAMP MOUNTING AND REPLACEMENT

The lamp is accessed by opening the rear cover by using two strong stainless steel quick release clips. When the rear cover is opened the power is automatically disconnected. The floodlight is available in two versions:

- With two power knife switches: when the cover is opened, the power supply to lampholders is directly interrupted.
- With one security knife switch: in this case the remote control switch must be connected to the poles of the terminal block inside the connection box. When the cover is opened, the remote control switch disconnects the power supply. Lamp replacement is achieved by opening the cover housing at an angle of 110° .

In case of lamp failure or at the end of lamp life, it's absolutely necessary to open the E switch to inhibit the ignitor's discharge, till the lamp is changed.

LAMPS



MD 2000W short arc



MD 2000W HF short arc



MD 1000W short arc

COLOUR



Silver

Photometric data



Lightmaster ONE R1

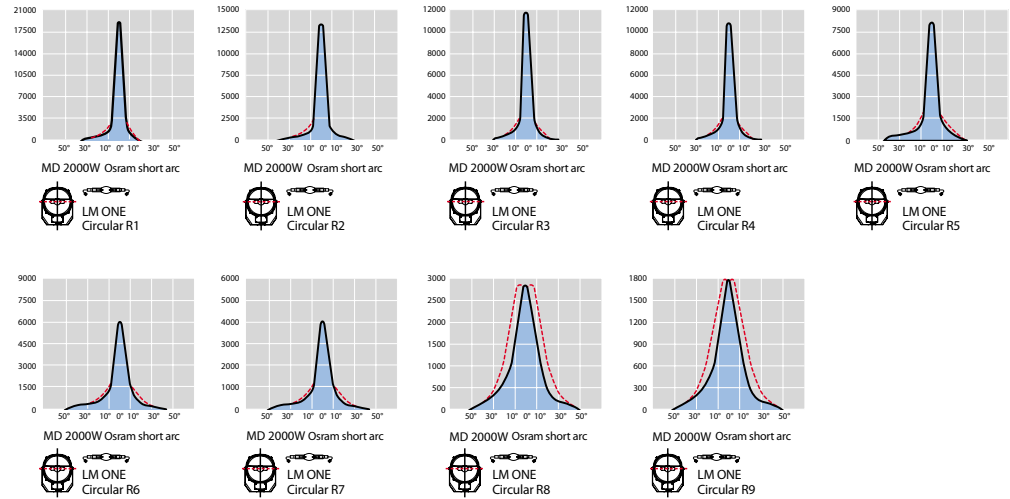

Lightmaster ONE R9

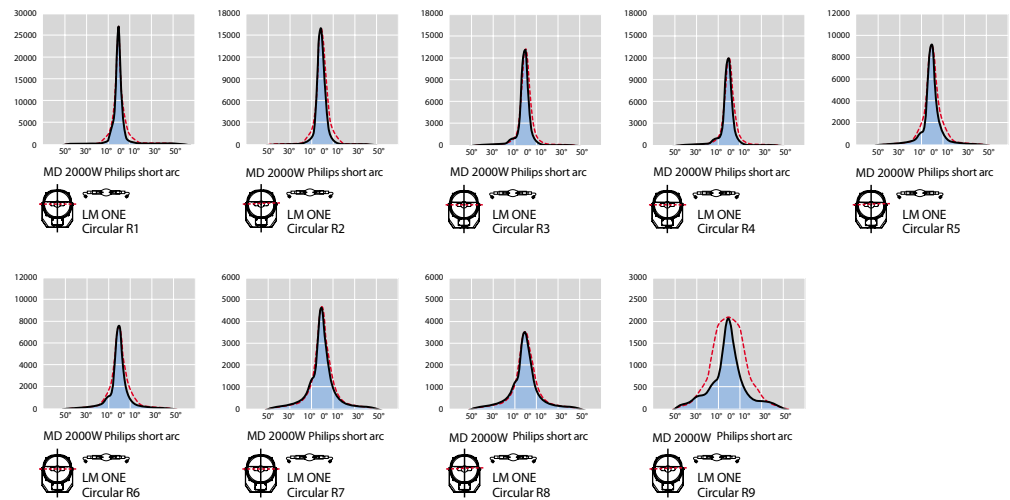

LIGHTING LEVELS RECOMMENDED BY FIFA FOR TV SHOOTINGS

Class	Calculation towards	VERTICAL ILLUMINANCE			HORIZONTAL ILLUMINANCE			PROPERTIES OF LAMPS	
		EV Ave	Uniformity		EH Ave	Uniformity		Colour temperature	Colour rendering
V international	Fixed camera	>2.000	0,6	0,7	3.500	0,6	0,8	>4.000	≥65
	Mobile camera (at pitch level)	1.800	0,4	0,65					
IV national	Fixed camera	2.000	0,5	0,65	2.500	0,6	0,8	>4.000	≥65
	Mobile camera (at pitch level)	1.400	0,35	0,6					

Vertical illuminance refers to illuminance toward selected camera position.

Products codes

LIGHTMASTER ONE - 1000W - CL I

CODE	DESCRIPTION	LAMP TYPE	WEIGHT (KG)	PACKING (PCS)	PALLET (PCS)	VOLUME
75231	Silver Body - Circular type R1	MD (JM-TS) 1000W short arc	15.50	1	12	0.1270
75232	Silver Body - Circular type R2	MD (JM-TS) 1000W short arc	15.50	1	12	0.1270
75233	Silver Body - Circular type R3	MD (JM-TS) 1000W short arc	15.50	1	12	0.1270
75234	Silver Body - Circular type R4	MD (JM-TS) 1000W short arc	15.50	1	12	0.1270
75235	Silver Body - Circular type R5	MD (JM-TS) 1000W short arc	15.50	1	12	0.1270
75236	Silver Body - Circular type R6	MD (JM-TS) 1000W short arc	15.50	1	12	0.1270
75237	Silver Body - Circular type R7	MD (JM-TS) 1000W short arc	15.50	1	12	0.1270
75238	Silver Body - Circular type R8	MD (JM-TS) 1000W short arc	15.50	1	12	0.1270
75239	Silver Body - Circular type R9	MD (JM-TS) 1000W short arc	15.50	1	12	0.1270

With two power knife switches when the cover is opened, the power supply to lampholders is directly interrupted.

LIGHTMASTER ONE - 1000W - CL I

CODE	DESCRIPTION	LAMP TYPE	WEIGHT (KG)	PACKING (PCS)	PALLET (PCS)	VOLUME
75281	Silver Body - Circular type R1	MD (JM-TS) 1000W short arc	15.50	1	12	0.1270
75282	Silver Body - Circular type R2	MD (JM-TS) 1000W short arc	15.50	1	12	0.1270
75283	Silver Body - Circular type R3	MD (JM-TS) 1000W short arc	15.50	1	12	0.1270
75284	Silver Body - Circular type R4	MD (JM-TS) 1000W short arc	15.50	1	12	0.1270
75285	Silver Body - Circular type R5	MD (JM-TS) 1000W short arc	15.50	1	12	0.1270
75286	Silver Body - Circular type R6	MD (JM-TS) 1000W short arc	15.50	1	12	0.1270
75287	Silver Body - Circular type R7	MD (JM-TS) 1000W short arc	15.50	1	12	0.1270
75288	Silver Body - Circular type R8	MD (JM-TS) 1000W short arc	15.50	1	12	0.1270
75289	Silver Body - Circular type R9	MD (JM-TS) 1000W short arc	15.50	1	12	0.1270

With one security knife switch version, the remote control switch must be connected to the poles of the terminal block inside the connection box. When the cover is opened, the remote control switch disconnects the power supply. Execution with hot restrike ignitor is available, on request, for the version with one security knife switch insulation CL I.

LIGHTMASTER ONE - 2000W - CL I

CODE	DESCRIPTION	LAMP TYPE	WEIGHT (KG)	PACKING (PCS)	PALLET (PCS)	VOLUME
75031	Silver Body - Circular type R1	MD (JM-TS) 2000W short arc	15.50	1	12	0.1270
75032	Silver Body - Circular type R2	MD (JM-TS) 2000W short arc	15.50	1	12	0.1270
75033	Silver Body - Circular type R3	MD (JM-TS) 2000W short arc	15.50	1	12	0.1270
75034	Silver Body - Circular type R4	MD (JM-TS) 2000W short arc	15.50	1	12	0.1270
75035	Silver Body - Circular type R5	MD (JM-TS) 2000W short arc	15.50	1	12	0.1270
75036	Silver Body - Circular type R6	MD (JM-TS) 2000W short arc	15.50	1	12	0.1270
75037	Silver Body - Circular type R7	MD (JM-TS) 2000W short arc	15.50	1	12	0.1270
75038	Silver Body - Circular type R8	MD (JM-TS) 2000W short arc	15.50	1	12	0.1270
75039	Silver Body - Circular type R9	MD (JM-TS) 2000W short arc	15.50	1	12	0.1270

With two power knife switches when the cover is opened, the power supply to lampholders is directly interrupted.

LIGHTMASTER ONE - 2000W - CL I

CODE	DESCRIPTION	LAMP TYPE	WEIGHT (KG)	PACKING (PCS)	PALLET (PCS)	VOLUME
75081	Silver Body - Circular type R1	MD (JM-TS) 2000W short arc	15.50	1	12	0.1270
75082	Silver Body - Circular type R2	MD (JM-TS) 2000W short arc	15.50	1	12	0.1270
75083	Silver Body - Circular type R3	MD (JM-TS) 2000W short arc	15.50	1	12	0.1270
75084	Silver Body - Circular type R4	MD (JM-TS) 2000W short arc	15.50	1	12	0.1270
75085	Silver Body - Circular type R5	MD (JM-TS) 2000W short arc	15.50	1	12	0.1270
75086	Silver Body - Circular type R6	MD (JM-TS) 2000W short arc	15.50	1	12	0.1270
75087	Silver Body - Circular type R7	MD (JM-TS) 2000W short arc	15.50	1	12	0.1270
75088	Silver Body - Circular type R8	MD (JM-TS) 2000W short arc	15.50	1	12	0.1270
75089	Silver Body - Circular type R9	MD (JM-TS) 2000W short arc	15.50	1	12	0.1270

With one security knife switch version, the remote control switch must be connected to the poles of the terminal block inside the connection box. When the cover is opened, the remote control switch disconnects the power supply. Execution with hot restrike ignitor is available, on request, for the version with one security knife switch insulation CL I.

LIGHTMASTER ONE - 2000W HF VERSION - CL I

CODE	DESCRIPTION	LAMP TYPE	WEIGHT (KG)	PACKING (PCS)	PALLET (PCS)	VOLUME
75111	Silver Body - Circular type R1	MD (JM-TS) 2000W HF short arc	15.50	1	12	0.1270
75112	Silver Body - Circular type R2	MD (JM-TS) 2000W HF short arc	15.50	1	12	0.1270
75113	Silver Body - Circular type R3	MD (JM-TS) 2000W HF short arc	15.50	1	12	0.1270
75114	Silver Body - Circular type R4	MD (JM-TS) 2000W HF short arc	15.50	1	12	0.1270
75115	Silver Body - Circular type R5	MD (JM-TS) 2000W HF short arc	15.50	1	12	0.1270
75116	Silver Body - Circular type R6	MD (JM-TS) 2000W HF short arc	15.50	1	12	0.1270
75117	Silver Body - Circular type R7	MD (JM-TS) 2000W HF short arc	15.50	1	12	0.1270
75118	Silver Body - Circular type R8	MD (JM-TS) 2000W HF short arc	15.50	1	12	0.1270
75119	Silver Body - Circular type R9	MD (JM-TS) 2000W HF short arc	15.50	1	12	0.1270

With two power knife switches when the cover is opened, the power supply to lampholders is directly interrupted.

The versions with two power knife switches are available also in insulation CL II.

Accessories and spare parts

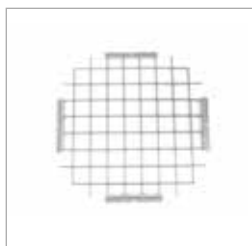

60410
Protection grille in galvanized steel, coated in silver colour.



60412
Circular louvre in stainless steel, coated in silver colour.

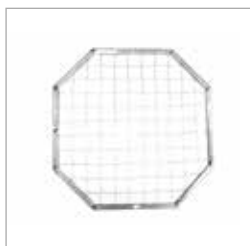

60414
Safety grid in stainless steel.

LIGHTMASTER ONE

CODE	DESCRIPTION	WEIGHT (KG)	COLOUR	LAMP TYPE	VOLUME
60410	Grille	0.75	Silver		
60412	Circular louvre	2.10	Silver		0.0670
60414	Safety grid	0.70			
12144	Glass				
10240	Osram lamp short arc 6100K	0.35		HQI-TS 2000W/D/S	
10819	Osram lamp short arc 6200K	0.35		HQI-TS 2000W/D/S HF	
10292	Osram lamp short arc 4400K	0.30		HQI-TS 1000W/NDL/S	
10293	Osram lamp short arc 6100K	0.30		HQI-TS 1000W/D/S	
13110	Osram lamp short arc 4450K	0.35		HQI-TS 2000W/NDL/S	
13111	Philips lamp short arc 5600K	0.35		MHN-SB 2000W/956	
07130	Ignitor 5kV 400V for Osram lamp 2000W SUPER	0.35			
00878	Ignitor 4kV 230V 1000W	0.25			
06901	Ballast 2000W 10,3A 400V	15.00			0.0030
17768	Ballast 2000W HF 12,2A 400V	18.00			0.0035
02955	Ballast 1000W 10,3A 230V	10.00			0.0027
14342*	Capacitor 30uF 450V for 2000W - aluminium case	0.25			
17769*	Capacitor 35 µF 400V for 2000W HF - aluminium case	0.25			
09569*	Capacitor 50uF 280V for 1000W - aluminium case	0.30			
60401**	Connecting plate 2000W 380-400-415V 50Hz 10,3A for installation in cabinets (power supply losses 100W)	17.10			0.0200
60428**	Connecting plate 2000W 400V 50Hz 12,2A for installation in cabinets (power supply losses 100W)	19.10			0.0200

* Wiring box: 2 capacitors for each lamps.

** Without ignitor: the size of the cabinet, in which plates would be installed, should be calculated by the designer.