

# Energy-saving floodlight



Jet 1000-2000 are advanced floodlights which combine high efficiency light output with high photometric performances they have been designed particularly for:

- outdoor and indoor sports halls.
- large areas.

Reflector made of highly pure, aluminium sheet, polished and oxidized.

Front tempered glass resistant to high temperatures and to thermal shock. Anti-ageing gaskets in silicon rubber.

Hot deep galvanized sheet steel fixing bracket, painted only for the JET 1000 symmetrical, with

index for vertical orientation.

The wiring compartment can be used as a junction box, or as housing for the ignitor (to be supplied separately).

CABLO SERVICE series boxes complete with electrical accessories are available for the power supply of the lamp.

Anti-screwing out device E40 lampholder.

PG 13,5 cable gland .

All the electrical components are suitable for power 230V - 50Hz and the projector is manufactured according to EN 60598/1 rules.



# JET 1000 Symmetrical



High efficiency projector for metal halide and high pressure 1000W lamps. "Leader" version is supplied with incorporated control gear and metal halide 1000W lamp, Osram or Philips. Die cast aluminium body and frame coated with polyester powders in black colour, complete with thermally ignitor housing. Electrical housing cover made of technopolymer.

## Optical system

The symmetrical optics with two different reflectors (peened and specular) guarantees medium-wide and mediumnarrow beams. The accuracy of these reflectors enables a perfect control of the luminous flux and a considerable glare reduction. The flux reflecting skirt ensures high performances.

wind exposed surface = 0,203 m<sup>2</sup>

## Lamps

	MT (JM-T) 1000W E40
	ST (SAP-T) 1000W E40

## Dimensions (mm)

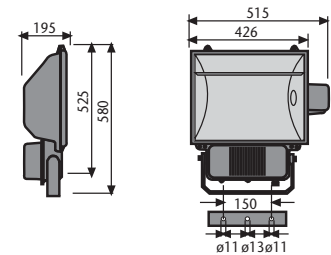

## Working position

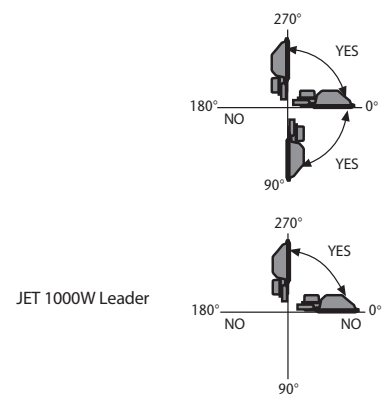

## Available colours



## CL I

	CODE	DESCRIPTION	LAMP TYPE	GROSS WEIGHT (kg)	PACKING (pcs.)	PALLET (pcs.)	CBMS
	50494	Black Body E 40 peened	M (JM) 1000W Osram type	9,70	1	25	0,0648
	50495	Black Body E 40 specular	M (JM) 1000W Osram type	9,70	1	25	0,0648
	50497	Black Body E 40 peened	M (JM) 1000W Philips type S (SAP) 1000W	9,70	1	25	0,0648
	50498	Black Body E 40 specular	M (JM) 1000W Philips type S (SAP) 1000W	9,70	1	25	0,0648
	50570	<b>CRL LEADER</b> peened - Black	M (JM) 1000W Philips type	17,73	1	25	0,0648
	50571	<b>CRL LEADER</b> specular - Black	M (JM) 1000W Philips type	17,73	1	25	0,0648
	50693	<b>CRL LEADER</b> peened - Black	M (JM) 1000W Osram type	20,60	1	25	0,0648
	50694	<b>CRL LEADER</b> specular - Black	M (JM) 1000W Osram type	20,60	1	25	0,0648

# JET 1000 Asymmetrical



High efficiency projector for 1000W metal halide and high pressure sodium lamps.  
It's also available a floodlight completely wired with metal halide or high pressure sodium lamp 1000W, called "SOLAR".

Body and cable compartment in pressed sheet aluminium coated with black polyester powder.  
Stainless steel springs for closing the frame.

## Optical system

The projector is supplied with two types of emissions:

Asy1: Max. intensity at approx. 50° recommended for the lighting of large areas (aimings towards the vertical between -20° and + 25°)

Asy2: Max. intensity at approx. 30° recommended for indoor lighting (aimings towards the vertical between -10° and + 40°).

And with two types of asymmetrical optics:

- Peened with a wide beam
- Specular with a narrow beam

A careful study permits excellent control of the luminous flux and a considerable glare reduction.

wind exposed surface = 0,275 m<sup>2</sup>

## Lamps

	MT (JM-T) 1000W E40
	ST (SAP-T) 1000W E40

## Dimensions (mm)

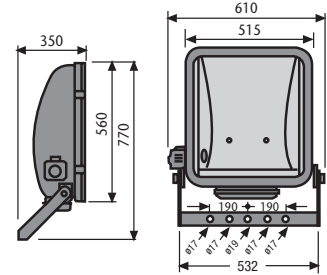

## Working position

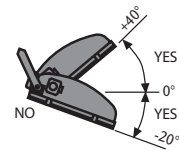

## Available colours



BLACK

## CL I

CODE	DESCRIPTION	LAMP TYPE	GROSS WEIGHT (kg)	PACKING (pcs.)	PALLET (pcs.)	CBMS
50612	Black Body E40 - 50° Peened refl. with flux reflecting skirt	M (JM) 1000W - S (SAP)	18,60	1	10	0,149
50613	Black Body E40 - 50° Specular refl. with flux reflecting skirt	M (JM) 1000W - S (SAP)	18,60	1	10	0,149
50622	Black Body E40 - 50° Peened refl. without flux reflect. skirt	M (JM) 1000W - S (SAP)	18,60	1	10	0,149
50623	Black Body E40 - 50° Specular refl. without flux reflect. skirt	M (JM) 1000W - S (SAP)	18,60	1	10	0,149
50614	SOLAR - 50° - Black Peened refl. with flux reflecting skirt	M (JM) 1000W Philips type	27,35	1	10	0,167
50615	SOLAR - 50° - Black Specular refl. with flux reflecting skirt	M (JM) 1000W Philips type	27,35	1	10	0,167
50624	SOLAR - 50° - Black Peened refl. without flux reflect. skirt	M (JM) 1000W Philips type	27,35	1	10	0,167
50625	SOLAR - 50° - Black Specular refl. without flux reflect. skirt	M (JM) 1000W Philips type	27,35	1	10	0,167
50698	SOLAR - 50° - Black Specular refl. with flux reflecting skirt	M (JM) 1000W Osram type	28,70	1	10	0,167
50699	SOLAR - 50° - Black Peened refl. with flux reflecting skirt	M (JM) 1000W Osram type	28,70	1	10	0,167
50704	SOLAR - 50° - Black Specular refl. with flux reflecting skirt	S (SAP) 1000W	28,70	1	10	0,167
50705	SOLAR - 50° - Black Peened refl. with flux reflecting skirt	S (SAP) 1000W	28,70	1	10	0,167
50626	Black Body E40 - 30° Peened refl. without flux reflect. skirt	M (JM) 1000W - S (SAP)	18,60	1	10	0,149
50627	Black Body E40 - 30° Specular refl. without flux reflect. skirt	M (JM) 1000W - S (SAP)	18,60	1	10	0,149
50641	SOLAR - 30° - Black Peened refl. without flux reflect. skirt	M (JM) 1000W Philips type	27,35	1	10	0,167
50640	SOLAR - 30° - Black Specular refl. without flux reflect. skirt	M (JM) 1000W Philips type	27,35	1	10	0,167

# JET 1000

## ACCESSORIES AND SPARE PARTS

CODE	DESCRIPTION	GROSS WEIGHT (kg)	COLOUR	1000W LAMP TYPE	CBMS
<b>JET 1000 Symmetrical</b>					
60339	Louvre	1,35	Black	-	0,0100
60349	Grille	0,75	Black	-	0,0030
05769	Glass	1,50	-	-	-
00878	4 KV ignitor	0,21	-	M-S (JM-SAP) Osram S (SAP) Philips	-
04644	1,2 KV ignitor for Philips lamp	0,10	-	M (JM) Philips	-
<b>JET 1000 Asymmetrical</b>					
60092	Steel anti-glare louvre	1,35	Black	-	0,0100
60050	Grille	1,20	Black	-	0,0055
00878	4 KV ignitor	0,21	-	M-S (JM-SAP) Osram S (SAP) Philips	-
04644	1,2 KV ignitor for Philips lamp	0,10	-	M (JM) Philips	-
07798	Frame with glass	5,50	Black	-	0,0260



**60349 - 60050**  
Steel protection grille.  
Zinc plated and steel coated in black colour.



**60339**  
Steel protection louvre.  
Zinc plated and steel coated in black colour.



**60092**  
Steel anti-glare louvre.  
Zinc plated and steel coated in black colour.

### Photometric data

#### JET 1000 Symmetrical

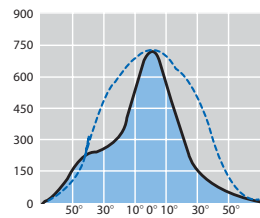

MT (JM-T) 1000W E40  
 JET 1000 Symmetrical Peened

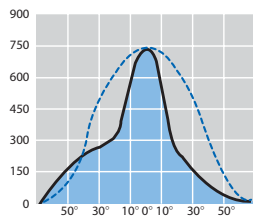

ST (SAP-T) 1000W E40  
 JET 1000 Symmetrical Peened

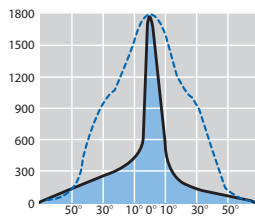

MT (JM-T) 1000W E40  
 JET 1000 Symmetrical Narrow

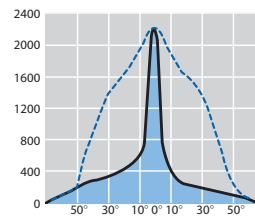

ST (SAP-T) 1000W E40  
 JET 1000 Symmetrical Narrow

#### JET 1000 Asymmetrical

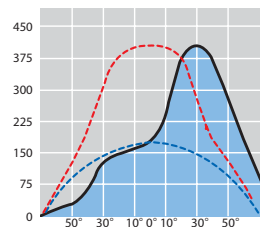

MT 1000 W E40  
 JET 1000 Asymm. 2 wide  
ø max 50°

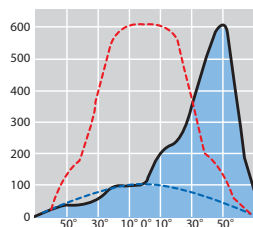

ST 1000 W E40  
 JET 1000 Asymm. 1 wide with refl. skirt  
ø max 50°

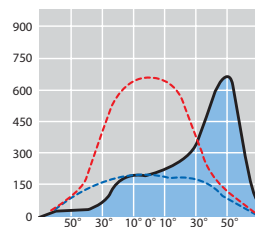

ST 1000 W E40  
 JET 1000 Asymm. 1 wide  
ø max 50°

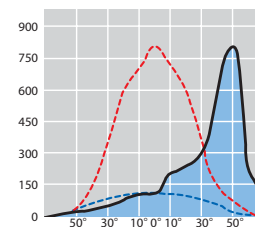

ST 1000 W E40  
 JET 1000 Asymm. 1 narrow with refl. skirt  
ø max 50°